

Features

- Two cross handles offer separate control of hot and cold water
- Part of the Occasion bathroom faucet and accessory collection
- Requires valve (sold separately) for installation

Material

- Premium metal construction for durability and reliability

Installation

- Wall-mount

Required Products/Accessories

- K-410-K Wall-mount Valve
- K-T27011-ND Wall-mount bathroom sink faucet spout with Straight design, 1.2 gpm

Recommended Products/Accessories

- K-23726 Drain treatment
- K-23723 Faucet cleaner
- K-27060 18" towel bar
- K-27061 24" towel bar
- K-27062 24" double towel bar
- K-27063 Towel ring
- K-27064 Vertical toilet paper holder
- K-27065 Pivoting toilet paper holder
- K-27069 Robe hook
- K-27128 Toilet paper holder with tray



ADA **CSA B651** **OBC**

Codes/Standards







ASME A112.18.1/CSA B125.1
 ADA
 ICC/ANSI A117.1
 CSA B651
 OBC
 IAPMO Certification

KOHLER® Faucet Lifetime Limited Warranty

See website for detailed warranty information.

Available Colors/Finishes

Color tiles intended for reference only.

Color	Code	Description
	CP	Polished Chrome
	SN	Vibrant® Polished Nickel
	BN	Vibrant® Brushed Nickel
	BL	Matte Black
	2MB	Vibrant® Brushed Moderne Brass
	BMB	Matte Black with Moderne Brass

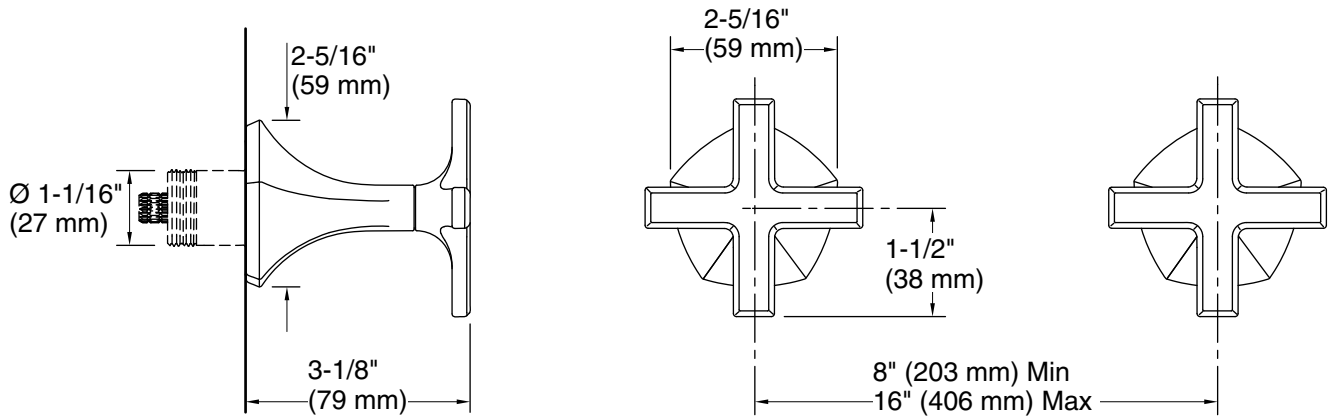

Technical Information

All product dimensions are nominal.

Faucet:

Flow rate: 1.2 gal/min (4.5 l/min)

Pressure: 60 psi (4.1 bar)

Drain included: No

Drain with overflow: No

Notes

ADA, OBC, CSA B651 compliant when installed to the specific requirements of these regulations.