

## Features

- Coordinates with other products in the Purist collection

## Material

- Premium metal construction for durability and reliability
- KOHLER finishes resist corrosion and tarnishing

## Installation

- Installation template and tools included



**ADA**

## Codes/Standards









ADA  
ICC/ANSI A117.1

## KOHLER® Faucet Lifetime Limited Warranty

See website for detailed warranty information.

## Available Colors/Finishes

*Color tiles intended for reference only.*

Color	Code	Description
	S	Polished Stainless
	SN	Vibrant™ Polished Nickel
	AF	Vibrant™ French Gold
	BN	Vibrant™ Brushed Nickel
	BS	Brushed Stainless
	BV	Vibrant™ Brushed Bronze
	BL	Matte Black
	2MB	Vibrant™ Brushed Moderne Brass
	TT	Vibrant Titanium

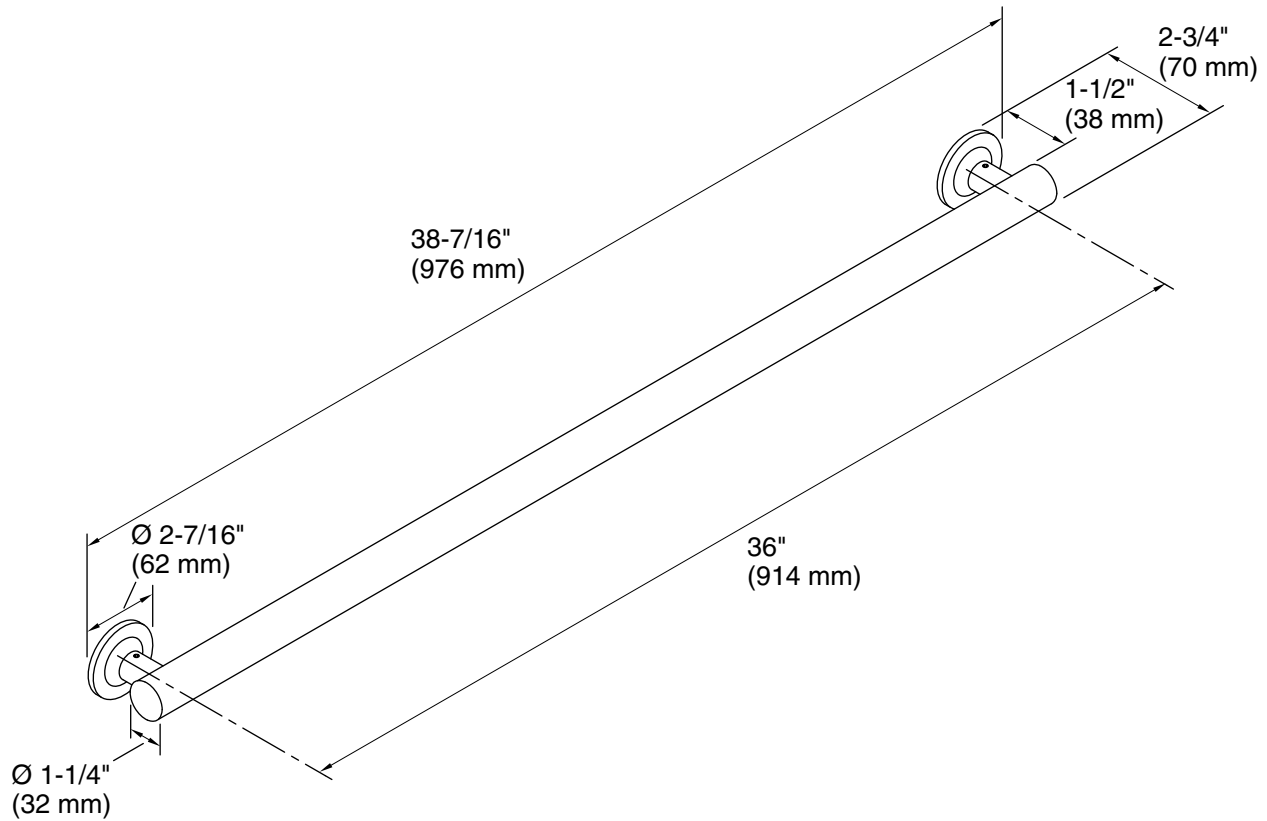

### Technical Information

All product dimensions are nominal.

Installation Type: Wall-mount

Material: Metal

### Notes

Measure your actual product for roughing-in details.

**WARNING:** Risk of personal injury. The wall plates on the grab bar must be mounted to a brace between the wall studs. This will ensure that the weight of the user is adequately supported.

ADA compliant when installed to the specific requirements of these regulations.