

Features

- Includes faceplate with handle.
- Single handle controls both on/off activation and temperature settings.
- Complements Purist faucets and accessories.

Material

- Premium material construction with metal handle ensures reliability and durability.
- KOHLER finishes resist corrosion and tarnishing.

Installation

- Trim only; requires valve to complete installation (sold separately).

Required Products/Accessories

K-304/K-P304 Series Rite-Temp® Valves

or

K-8304/K-P8304 Series Rite-Temp® Valve & Cartridge Kits

or

K-8300/K-P8300 Series Rite-Temp® Valve Body Rough-ins

K-8305/K-P8305 Series Rite-Temp® Cartridges

or

K-2971-KS 3/4" Pressure-balancing Valve

Recommended Products/Accessories

K-23723 Faucet cleaner

Optional Products/Accessories

K-10350 Deep rough-in kit

K-10351 Test cap for K-8300 Series valve bodies



ADA

CSA B651

OBC

Codes/Standards

ASME A112.18.1/CSA B125.1

ADA

ICC/ANSI A117.1

CSA B651









OBC

KOHLER® Faucet Lifetime Limited Warranty

See website for detailed warranty information.

Available Colors/Finishes

Color tiles intended for reference only.

Color	Code	Description
	CP	Polished Chrome
	SN	Vibrant® Polished Nickel
	BGD	Vibrant® Moderne Brushed Gold
	BN	Vibrant® Brushed Nickel
	BV	Vibrant® Brushed Bronze
	BL	Matte Black
	2MB	Vibrant® Brushed Moderne Brass
	RGD	Vibrant Rose Gold
	VHR	

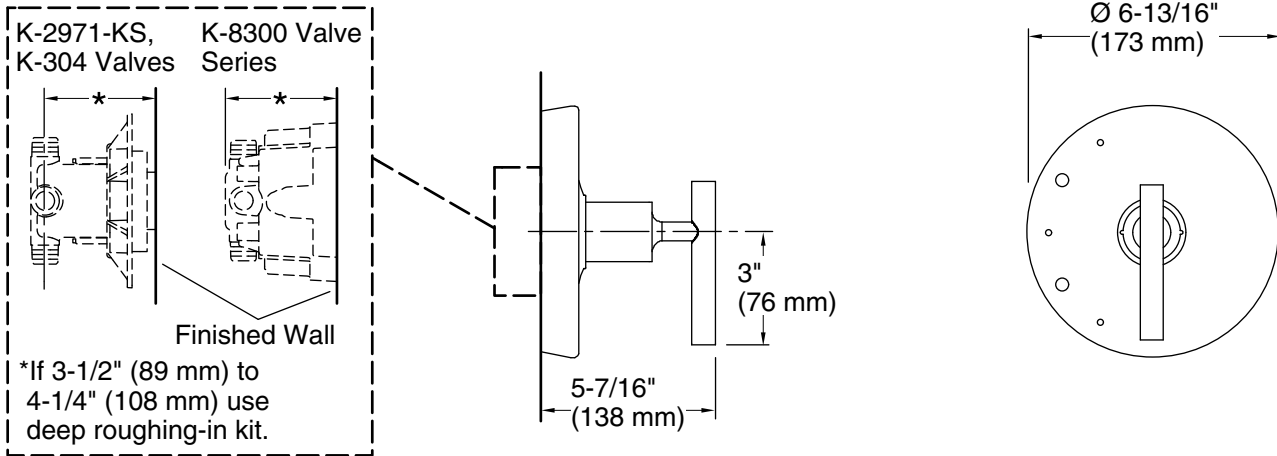

Technical Information

All product dimensions are nominal.

Showerhead/Body Spray:

Rated maximum flow: 2.5 gal/min (9.5 l/min)

Notes

Install the product according to the installation guide.

NOTICE: Risk of product damage. Long screws for installing trim can damage the K-2971-KS valve. Consult the trim installation guide to verify if the thin wall installation kit (88526) is needed.

ADA, OBC, CSA B651 compliant when installed to the specific requirements of these regulations.