

Features

- 1/2" NPT connections
- Available 27- or 54-nozzle configurations
- 2.0 gpm (7.6 lpm) maximum flow rate at 80 psi (5.5 bar)

Recommended Products/Accessories

K-23723 Faucet cleaner



Codes/Standards









ASME A112.18.1/CSA B125.1
DOE - Energy Policy Act 1992

KOHLER[®] Faucet Lifetime Limited Warranty

See website for detailed warranty information.

Available Colors/Finishes

Color tiles intended for reference only.

Color	Code	Description
	CP	Polished Chrome
	SN	Vibrant™ Polished Nickel
	AF	Vibrant™ French Gold
	BN	Vibrant™ Brushed Nickel
	BV	Vibrant™ Brushed Bronze
	2BZ	Oil-Rubbed Bronze
	BL	Matte Black
	2MB	Vibrant™ Brushed Moderne Brass
	TT	Vibrant Titanium

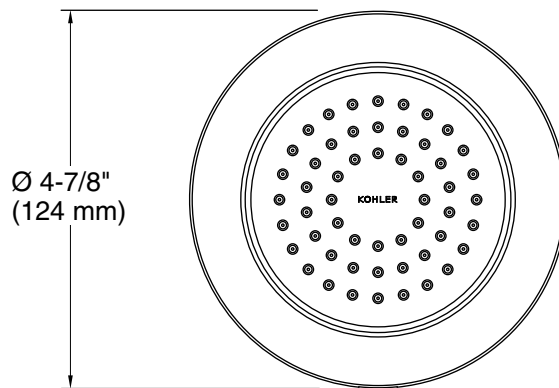
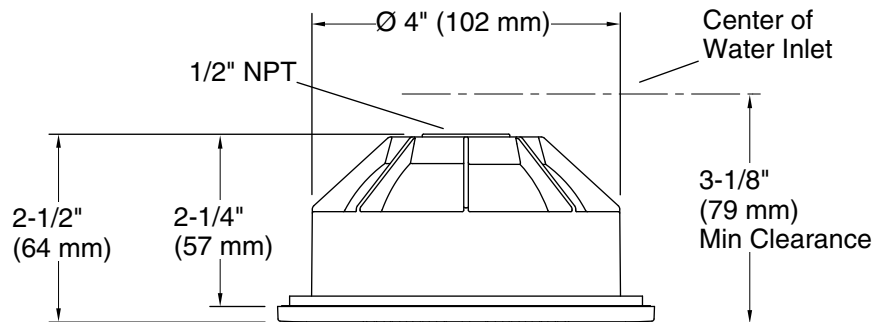

Technical Information

All product dimensions are nominal.

Notes

Install this product according to the installation instructions.