

Features

- Single-function rainhead
- MasterClean™ sprayface features an easy-to-clean surface that withstands mineral buildup
- Optimized sprayface for maximum performance
- 2.5 gpm (9.5 lpm) maximum flow rate

Material

- Solid-brass construction for durability and reliability

Technology

- Katalyst™ air-induction technology infuses water with air, creating bigger drops for a more powerful spray

Installation

- 1/2 -14 NPT connection



Codes/Standards







ASME A112.18.1/CSA B125.1
DOE - Energy Policy Act 1992

KOHLER® Faucet Lifetime Limited Warranty

See website for detailed warranty information.

Available Colors/Finishes

Color tiles intended for reference only.

Color	Code	Description
	CP	Polished Chrome
	SN	Vibrant™ Polished Nickel
	BN	Vibrant™ Brushed Nickel
	BV	Vibrant™ Brushed Bronze
	2MB	Vibrant™ Brushed Moderne Brass
	TT	Vibrant™ Titanium

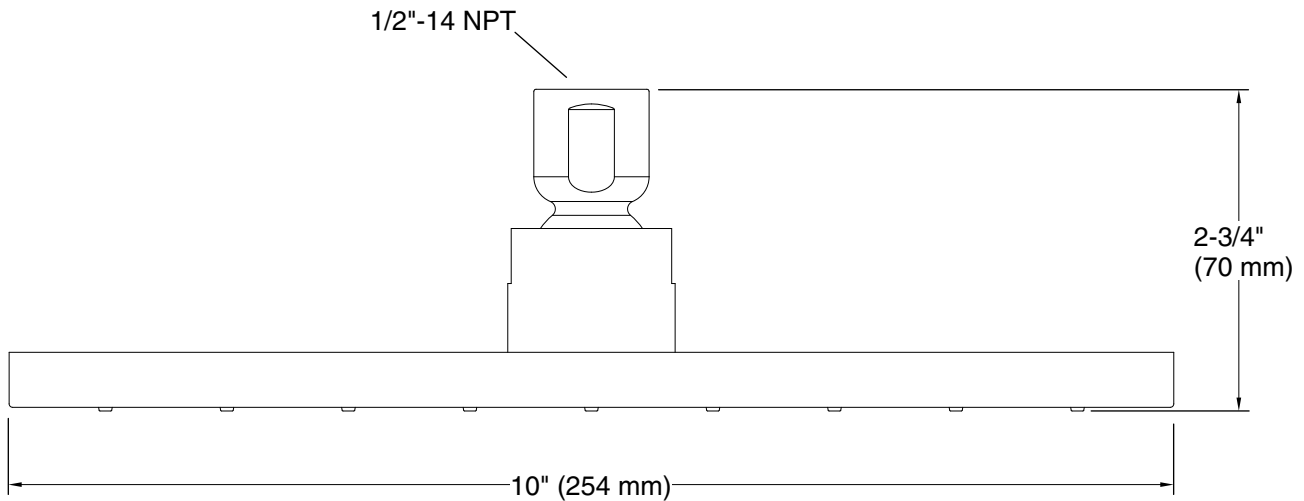

Technical Information

All product dimensions are nominal.

Showerhead/Body Spray:

Rated maximum flow: 2.5 gal/min (9.5 l/min)

Notes

Install this product in accordance with the installation instructions.