

Features

- Two lever handles offer separate control of hot and cold water.
- For use with Components K-77967, K-77965, K-77968, K-77966, or K-77969 spout (sold separately).
- Coordinates with Components faucets, accessories, and showering components to complete your bathroom.
- UltraGlide® valves with dry-stem technology are designed to eliminate common leak paths and provide smooth, effortless control.

Material

- Premium metal construction for durability and reliability.
- KOHLER finishes resist corrosion and tarnishing.

Installation

- For 8" - 16" (203 - 406 mm) centers.
- Handles are preassembled on valves to simplify installation.

Required Products/Accessories

K-77965 Bathroom sink spout with Tube design

or

K-77966 Bathroom sink spout with Ribbon design

or

K-77967 Bathroom sink spout with Tube design

or

K-77968 Bathroom sink spout with Ribbon design

or

K-77969 Bathroom sink spout with Row design

Recommended Products/Accessories

K-23887 Bathroom sink spout with Row design

K-23723 Faucet cleaner

Optional Products/Accessories

1303704 24" outlet hose assembly



ADA CSA B651 OBC

Codes/Standards

ASME A112.18.1/CSA B125.1

NSF/ANSI 61

NSF/ANSI 372

ADA

ICC/ANSI A117.1

CSA B651







OBC

KOHLER® Faucet Lifetime Limited Warranty

See website for detailed warranty information.

Available Colors/Finishes

Color tiles intended for reference only.

Color	Code	Description
	CP	Polished Chrome
	SN	Vibrant® Polished Nickel
	BN	Vibrant® Brushed Nickel
	BL	Matte Black
	2MB	Vibrant® Brushed Moderne Brass
	RGD	Vibrant Rose Gold
	TT	Vibrant Titanium

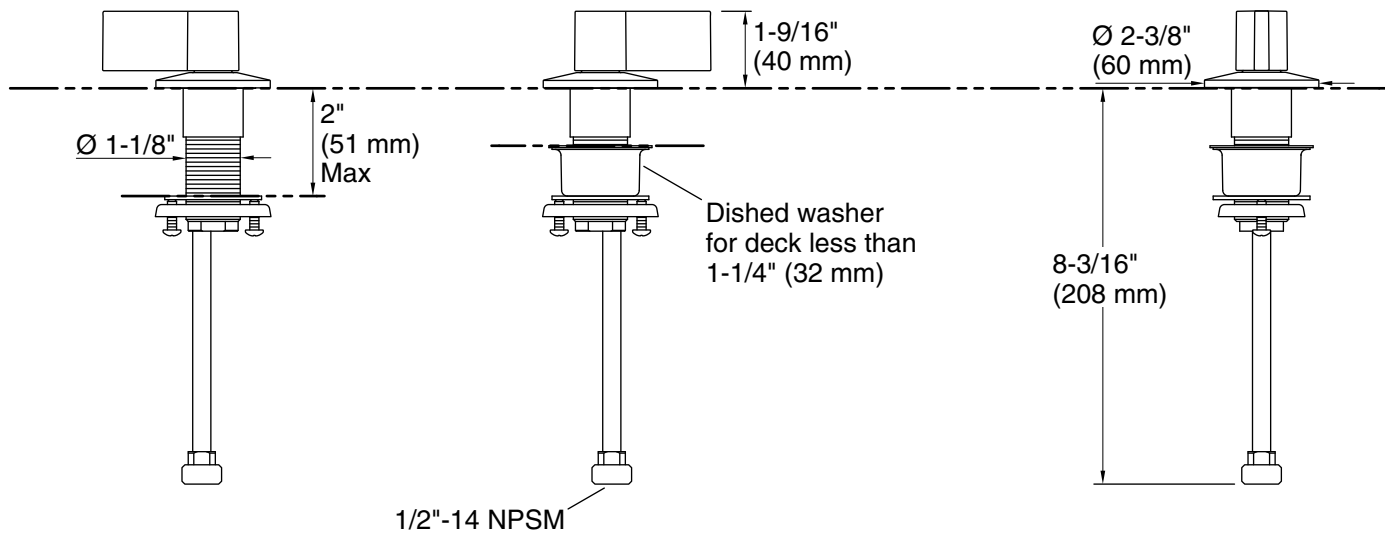

Technical Information

All product dimensions are nominal.

Drain included: No

Notes

Install this product according to the installation instructions.

ADA compliant for handles only.

ADA, OBC, CSA B651 compliant when installed to the specific requirements of these regulations.