

### Features

- Single lever handle allows for simultaneous on/off activation and temperature setting.
- KOHLER ceramic disc valves exceed industry longevity standards for a lifetime of durable performance.
- Includes Shift® handshower and 60" shower hose.
- Coordinates with Purist faucets, accessories, and showering components to complete your bathroom.
- 7 gpm (gallons per minute) at 45 PSI.
- 1.75 gpm (6.6 lpm) flow rate for handshower.

### Material

- Premium metal construction for durability and reliability.
- KOHLER finishes resist corrosion and tarnishing.

### Installation

- Floor-mount.
- Compatibility with bathtub varies by application.

### Required Products/Accessories

K-97339 Multiproduct Mounting-block

### Recommended Products/Accessories

K-23723 Faucet cleaner

### Included Components

Additional Components:

K-10257 Multifunction Handshower  
60" shower hose



### Codes/Standards







ASME A112.18.1/CSA B125.1  
DOE - Energy Policy Act 1992  
EPA WaterSense®  
California Energy Commission (CEC)

### KOHLER® Faucet Lifetime Limited Warranty

See website for detailed warranty information.

### Available Colors/Finishes

*Color tiles intended for reference only.*

Color	Code	Description
	CP	Polished Chrome
	SN	Vibrant® Polished Nickel
	BGD	Vibrant® Moderne Brushed Gold
	BN	Vibrant® Brushed Nickel
	BL	Matte Black
	2MB	Vibrant® Brushed Moderne Brass

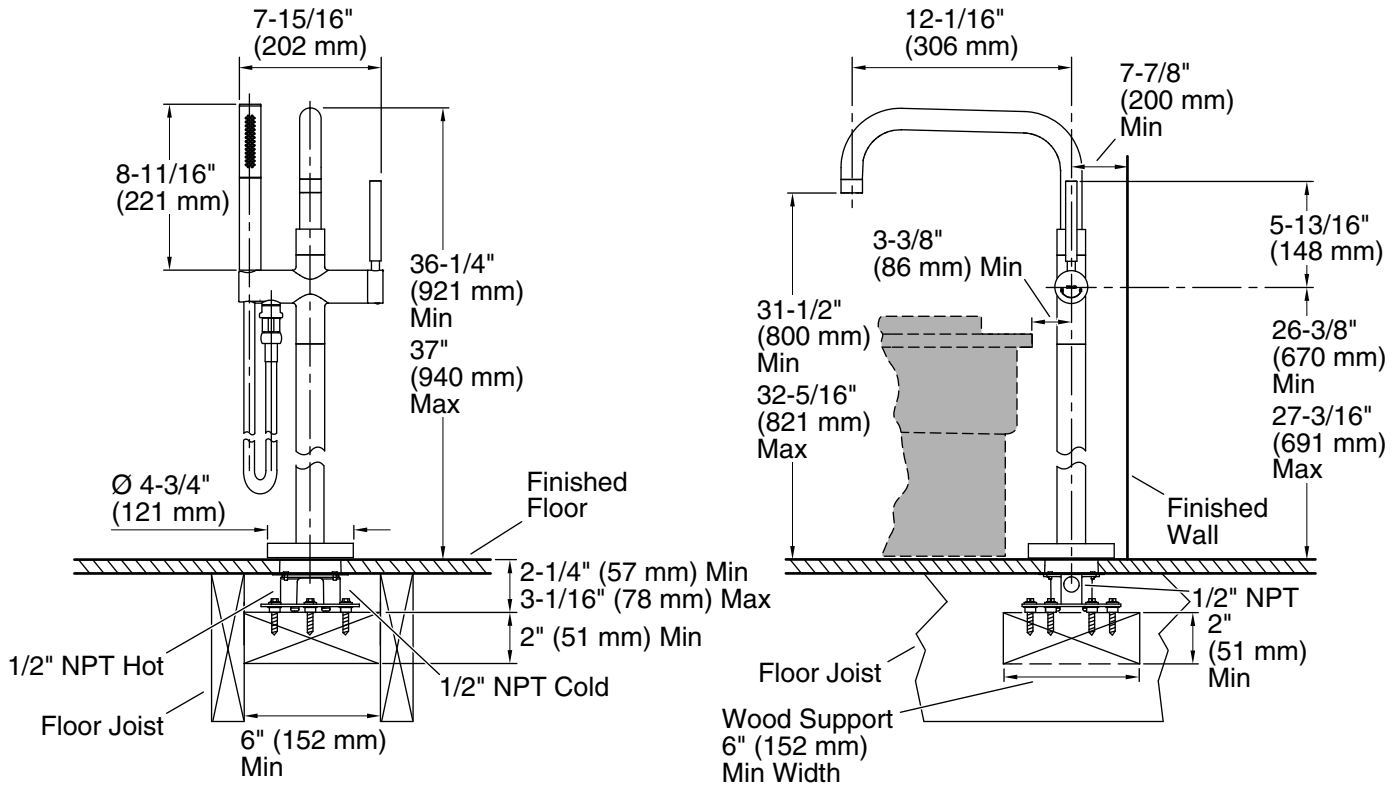

### Technical Information

All product dimensions are nominal.

#### Faucet:

Flow rate: 7 gal/min (26.5 l/min)  
 Pressure: 45 psi (3.1 bar)  
 Drain included: No

#### Spout:

Spout reach: 12-1/16" (306 mm)

#### Handshower:

Rated maximum flow: 1.75 gal/min (6.6 l/min)  
 Pressure: 80 psi (5.5 bar)

### Notes

Install this product according to the installation guide.

Adequate floor support is required. The wood support must be a minimum of 2" (51 mm) thick by 6" (152 mm) wide. 2x6 lumber is NOT adequate for this application.

Concrete can be used as the floor support. Requires 3/16" masonry drill bit and six 1/4" x 1-3/4" concrete screws, not included.