

Features

- One-piece, self-contained ceramic disc valve allows both volume and control.
- Clicker drain with tailpiece and overflow.
- 5-11/16" (144 mm) spout reach.
- 1.5 gpm (5.7 lpm) maximum flow rate at 60 psi (4.14 bar).

Material

- Brass.

Installation

- Flexible connections for easy installation.

Recommended Products/Accessories

- K-23726 Drain treatment
- K-23723 Faucet cleaner



Codes/Standards







ASME A112.18.1/CSA B125.1
NSF/ANSI 61
NSF/ANSI 372
All applicable US Federal and State material regulations
DOE - Energy Policy Act 1992
EPA WaterSense®
California Energy Commission (CEC)
ADA
ICC/ANSI A117.1
CSA B651
OBC

KOHLER® Faucet Lifetime Limited Warranty

See website for detailed warranty information.

Available Colors/Finishes

Color tiles intended for reference only.

| Color | Code | Description |
|---|------|--------------------------------|
|  | CP | Polished Chrome |
|  | SN | Vibrant® Polished Nickel |
|  | BN | Vibrant® Brushed Nickel |
|  | BV | Vibrant® Brushed Bronze |
|  | 2BZ | Oil-Rubbed Bronze |
|  | 2MB | Vibrant® Brushed Moderne Brass |
|  | VNT | Vintage Nickel |

1-800-4KOHLER (1-800-456-4537)

Kohler Co. reserves the right to make revisions without notice to product specifications.

For the most current Specification Sheet, go to www.kohler.com.

5-29-2021 22:01 - US/CA/MX

THE BOLD LOOK
OF **KOHLER®**

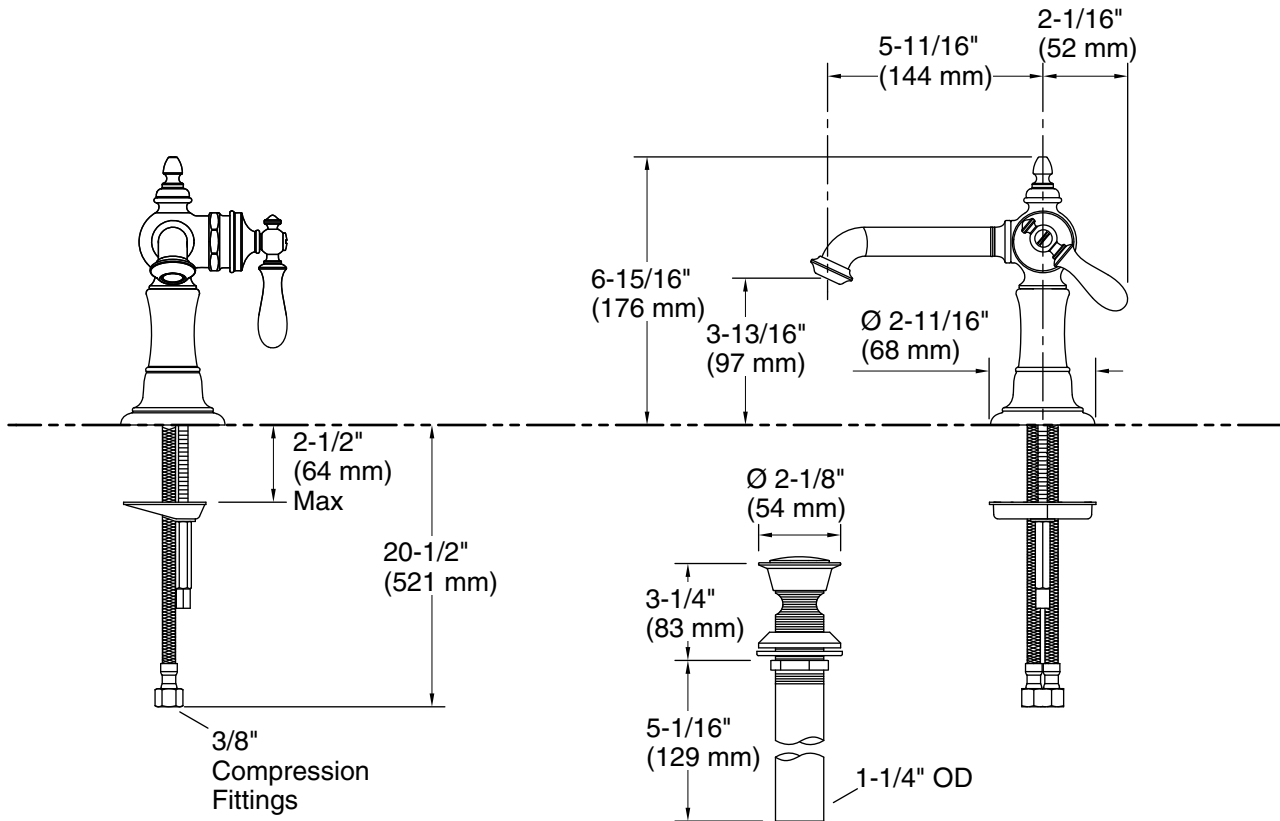

Technical Information

All product dimensions are nominal.

Faucet:

Flow rate: 1.5 gal/min (5.7 l/min)

Pressure: 60 psi (4.1 bar)

Drain included: No

Spout:

Spout reach: 5-11/16" (145 mm)

Notes

Install this product according to the installation guide.

ADA compliant for handles only.

ADA, OBC, CSA B651 compliant when installed to the specific requirements of these regulations.