

Features

- Metal construction.
- Pop-up drain with lift rod and tailpiece.
- 4-7/8" (124 mm) spout reach.
- Quarter-turn washerless ceramic disc valves.
- 1.2 gpm (4.5 lpm) maximum flow rate at 60 psi (4.14 bar).

Material

- Brass valve bodies.

Installation

- For 8" - 16" (203 - 406 mm) centers.

Recommended Products/Accessories

- K-23726 Drain treatment
- K-23723 Faucet cleaner



ADA **CSA B651** **OBC**

Codes/Standards







ASME A112.18.1/CSA B125.1
NSF/ANSI 61
NSF/ANSI 372
All applicable US Federal and State material regulations
DOE - Energy Policy Act 1992
EPA WaterSense®
California Energy Commission (CEC)
ADA
ICC/ANSI A117.1
CSA B651
OBC

KOHLER® Faucet Lifetime Limited Warranty

See website for detailed warranty information.

Available Colors/Finishes

Color tiles intended for reference only.

Color	Code	Description
	CP	Polished Chrome
	SN	Vibrant® Polished Nickel
	AF	Vibrant® French Gold
	BN	Vibrant® Brushed Nickel
	BV	Vibrant® Brushed Bronze
	BRZ	Oil-Rubbed Bronze
	2BZ	Oil-Rubbed Bronze

1-800-4KOHLER (1-800-456-4537)

Kohler Co. reserves the right to make revisions without notice to product specifications.

For the most current Specification Sheet, go to www.kohler.com.

5-29-2021 13:35 - US/CA/MX

THE BOLD LOOK
OF **KOHLER®**

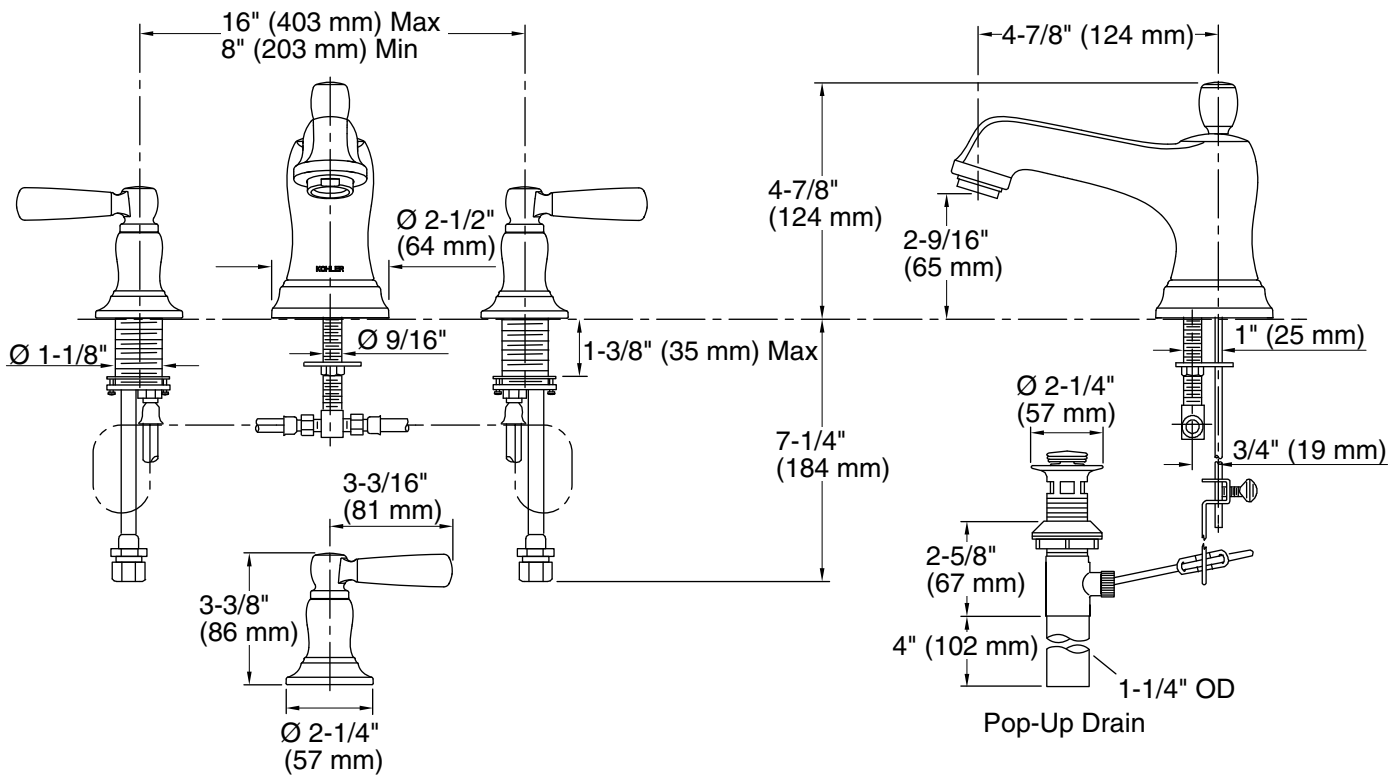

Technical Information

All product dimensions are nominal.

Faucet:

Flow rate: 1.2 gal/min (4.5 l/min)

Pressure: 60 psi (4.1 bar)

Drain included: Yes

Spout:

Spout reach: 4-7/8" (124 mm)

Notes

Install this product according to the installation guide.

ADA compliant for handles only.

ADA, OBC, CSA B651 compliant when installed to the specific requirements of these regulations.