

Features

- Overhanging lid design creates a clean and sleek look
- Quiet-Close™ elongated lid and seat prevents slamming
- Grip-Tight bumpers hold seat firmly in place
- Quick-Release™ functionality allows seat to be removed easily from toilet for convenient cleaning
- Quick-Attach® hardware for fast and secure installation
- Color-matched plastic hinges
- Elongated closed-front seat
- Contoured seat for user comfort
- Elegant lid design for a clean and sleek aesthetic

Material

- Plastic construction

Installation

- For nonresidential application, K-7671, K-20110, or K-25301 is recommended

Recommended Products/Accessories

K-26801 Impro™ ReadyLatch® Quiet-Close™ elongated toilet seat



Codes/Standards











None Applicable

KOHLER® One-Year Limited Warranty

See website for detailed warranty information.

Available Colors/Finishes

Color tiles intended for reference only.

Color	Code	Description
	0	White
	96	Biscuit
	NY	Dune
	95	Ice™ Grey
	G9	Sandbar
	K4	Cashmere
	58	Thunder™ Grey
	7	Black Black™
	H15	Spring Green
	V10	Peachblow

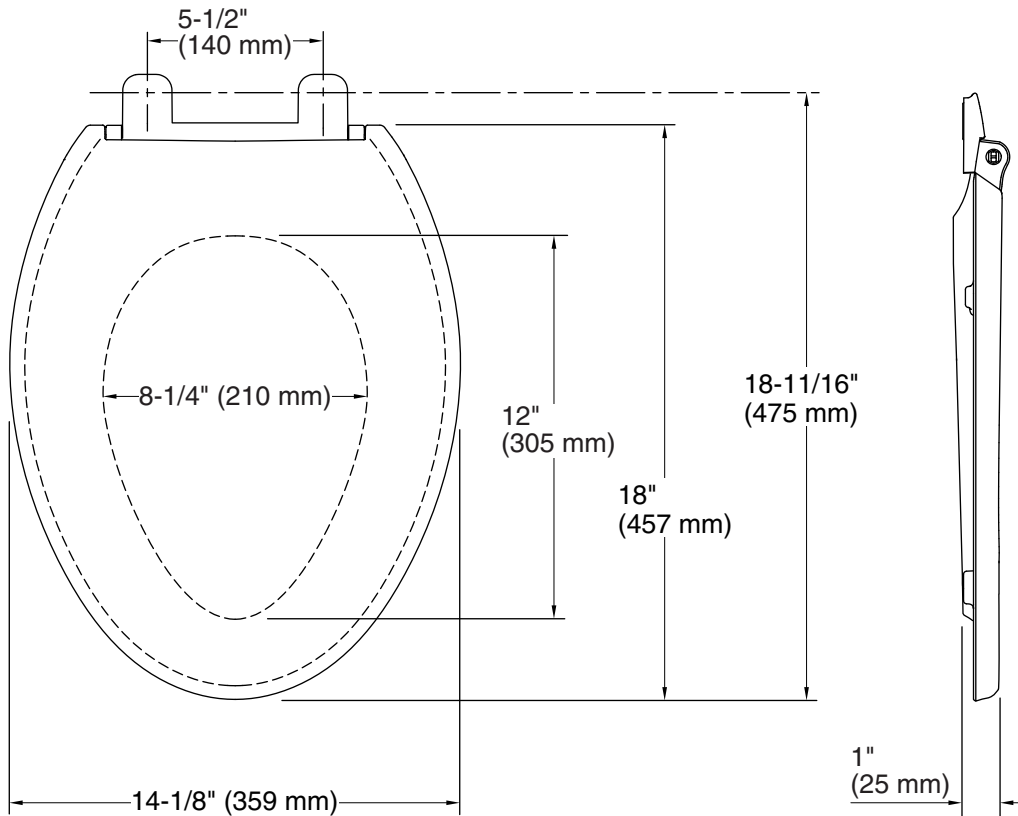

Technical Information

All product dimensions are nominal.

Seat shape type: Elongated
Seat front type: Closed-front
Seat-mounting holes: 5-1/2" (140 mm)

Notes

Install this product according to the installation guide.